

FITTINGS— for double union ball valves in PPGF and PVDF

Series 1003, 2003, 2027, 2035, 2038 and check valve 2001, 2068

FOR THE PRODUCTS

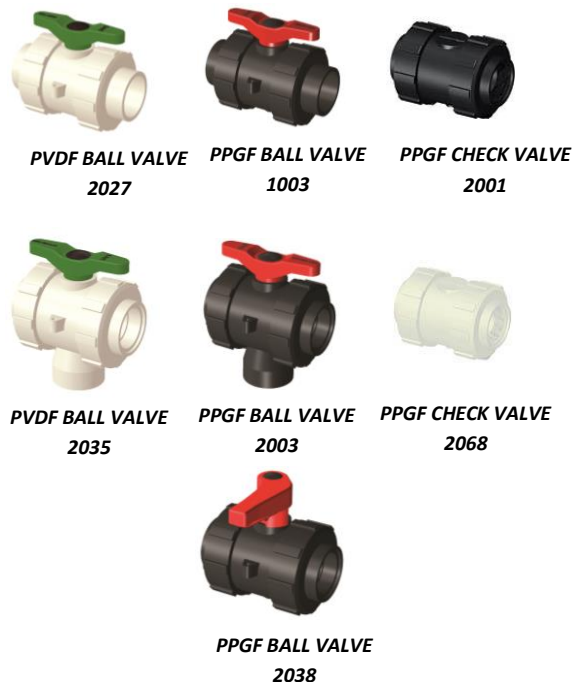
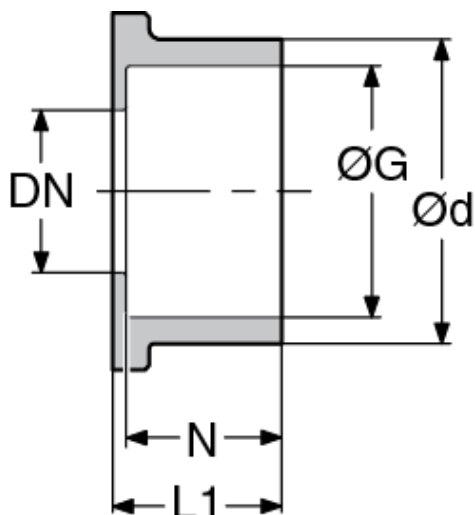

MAIN FEATURES

- These fittings are assembled on the double union ball valves series : 1003, 2003, 2027, 2035, 2038 and check valves series : 2001 and 2068
- Available fittings :
 - BSP Threaded socket
 - Metric socket
 - Assembly of "DIN" flange (EN1092-1 PN10/16) nut, socket and O-ring
 - NPT threaded socket (PVC-U)
 - SCH80 socket
 - Assembly of "ANSI" flange (ASME B16.5 class 150) nut, socket and O-ring
 - PE-HD metric spigot for electrofusion
- Contact us for any other type of fittings.

Les descriptions et caractéristiques figurant sur ce document sont données uniquement à titre d'information et non d'engagement contractuel. SAFI se réserve le droit d'effectuer sans préavis, toute modification.

SAFI has a policy of continuously developing its product range and the above data is subject to change without prior notification.

Die Beschreibungen und Daten, die sich auf diesem Dokument befinden, sind rein informativ und unverbindlich. SAFI behält sich vor, ohne Vorankündigung Änderungen vorzunehmen, die als technisch notwendig erachtet werden.

Las descripciones y características que figuran en este documento son indicativas. En ningún caso son contractuales. SAFI se reserva el derecho sin previo aviso de efectuar cualquier modificación.

SAFI

Av. Jacques Moison – BP 1
26770 TAULIGNAN
FRANCE
Tél.: (+33) 4 75 53 56 29
Fax : (+33) 4 75 53 62 78
info@safi-valves.com

SAFI Limited

35 Holton Road
Holton Heath Trading Park
POOLE Dorset - BH16 6LT
UNITED KINGDOM
Tél.: (+44) 1202 624618
Fax : (+44) 1202 628500
sales@safi-valves.com

SAFI Deutschland

Kunststoffarmaturen
Vertriebs GmbH
Jahnstrasse 29
64319 PFUNGSTADT
DEUTSCHLAND
Tél. : (+49) 61 57 81 919
Fax : (+49) 61 57 82 025
info-deutschland@safi-valves.com

SAFI Fabrica de Valvulas

C/ Carboners, 35
Pol. Ind. La Cometa
43700 EL VENDRELL
TARRAGONA-ESPAÑA
Tel.: (+34) 977 665 147
Fax : (+34) 977 664 989
info@safi-valvulas.com

SAFI America

Las Garzas Trade Center
Las Garzas #950, B
Quilicura
SANTIAGO – CHILE
Tél.: (+56 2) 2 510 3500
Fax : (+56 2) 2 510 3507
info@safi-america.com

PPGF BSP THREADED SOCKET

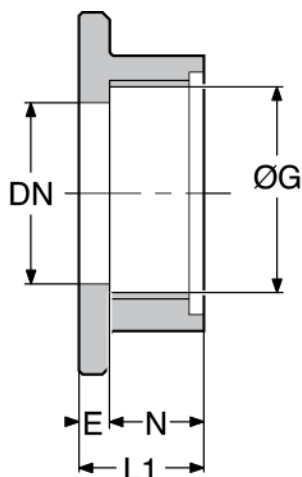

Dimensions					PRODUCT CODE
G	DN	E	L1	N	PPGF
inch	mm	mm	mm	mm	
1/2"	15	5	22,5	17,5	2016-00E
3/4"	20	5	25,5	20,5	2016-01E
1"	25	6,3	28	23,5	1003-02E
1"1/4	32	6,6	32	27,5	1003-03E
1"1/2	40	8,5	32	24,5	1003-04E
2"	50	9	34,5	24,5	1003-05E

PPGF BSP THREADED SPIGOT

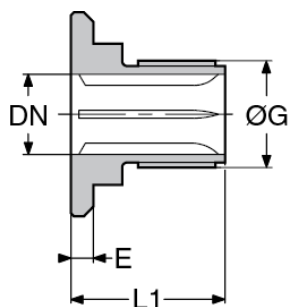
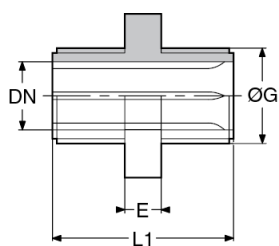

Dimensions					PRODUCT CODE
d	DN	G	L1	E	PPGF
mm	mm	inch	mm	mm	
20	15	1/2"	40,5	8	1003-00Q *
25	20	3/4"	40,5	8	1003-01Q *
32	25	1"	48	7,5	1003-02H
40	32	1"1/4	48	7,5	1003-03H
50	40	1"1/2	48	7,5	1003-04H
63	50	2"	48,5	10	1003-05H

*: these codes are mounted on a valve with threaded sockets

Assembly of "DIN/ANSI" flange, nut, socket and O-ring

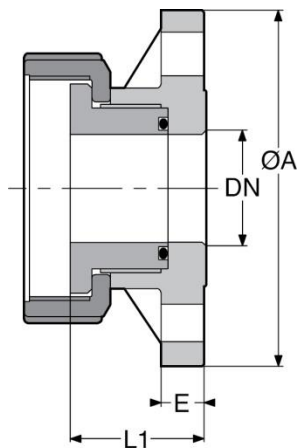

Dimensions					PRODUCT CODE	
DN	G	ØA	E	L1	PPGF EPDM seals	PPGF FPM seals
mm	inch	mm	mm	mm		
15	1/2"	-	-	-	Consult us	Consult us
20	3/4"	-	-	-	Consult us	Consult us
25	1"	115	15,5	40	2018D22EP	2018D22VT
32	1"1/4	140	18	47,5	2018D23EP	2018D23VT
40	1"1/2	150	17	49,5	2018D24EP	2018D24VT
50	2"	165	19	63	2018D25EP	2018D25VT
65	2"1/2	185	20	92	2018D26EP	2018D26VT

DIN = Drilling in accordance with EN 1092-1 PN10/PN

ANSI = Drilling in accordance with EN1759-1/ASME B16.5 Class 150

PPGF HOSETAIL SPIGOT

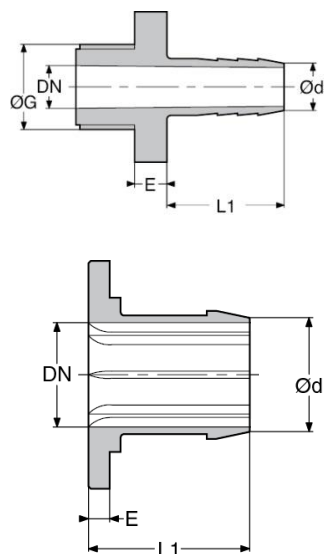

Dimensions					PRODUCT CODE
DN	G	ØA	L1	E	PPGF
mm	inch	mm	mm	mm	
15	1/2"	14	29	8	1062-16G *
20	3/4"	20	37	8	1062-16L *
25	1"	25	68	8	1005-47T
32	1"1/4	30	68	8	1005-39T
40	1"1/2	40	68	9	1005-13T
50	2"	50	68	9	1005-45T

*: these codes are mounted on a valve with threaded sockets

PPGF CAMLOCK SPIGOT

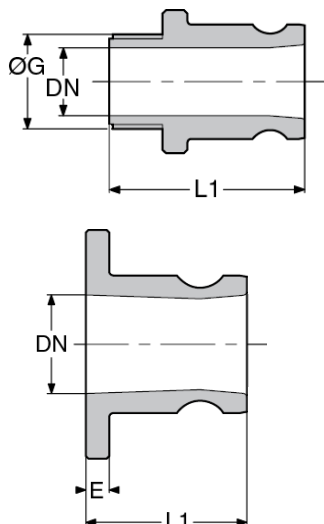

Dimensions					PRODUCT CODE
DN		G	E	L1	PPGF
mm	inch				
20	15	1/2"	-	51,6	2009-00F *
25	20	3/4"	-	52,7	2009-01F *
32	25	1"	5	46	1005-15k
40	32	1"1/4	7	55	1005-14K
50	40	1"1/2	9	61,5	1005-13K
63	50	2"	9	63	1005-45K

*: these codes are mounted on a valve with threaded sockets

PPGF FNPT THREADED SOCKET

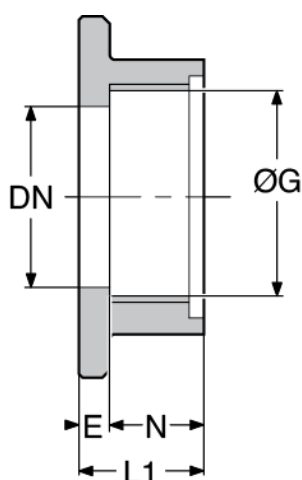

Dimensions					PRODUCT CODE
G	DN	E	L1	N	PPGF
inch	mm	mm	mm	mm	
1/2" NPT	15	5	22,5	17,5	2016-00E
3/4" NPT	20	5	25,5	20,5	2016-01E
1" NPT	25	6,5	23	17	2003-02E
1"1/4 NPT	32	7	24	17	2003-03E
1"1/2 NPT	40	8	24	17	2003-04E
2" NPT	50	8,5	32	22	2003-05E

PVC-U METRIC SOCKET

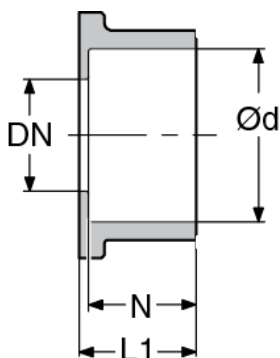

Dimensions					PRODUCT CODE
d	DN	G	L1	N	PVC-U
mm	mm	inch	mm	mm	
20	15	1/2"	21	16,5	2016-00P
25	20	3/4"	24,5	20	2016-01P
32	25	1"	26,5	22,5	1003-02P
40	32	1"1/4	31	27,5	1003-03P
50	40	1"1/2	37,5	31,5	1003-04P
63	50	2"	44	38	1003-05P

PVC-U IMPERIAL SOCKET

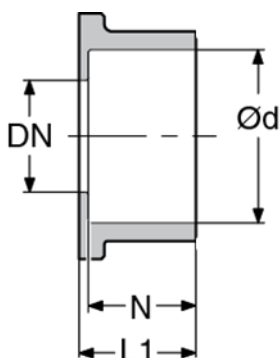

Dimensions					PRODUCT CODE
d	DN	G	L1	N	PVC-U
mm	mm	inch	mm	mm	
20	15	1/2"	22	17	2003-10U
25	20	3/4"	22	20	2003-11U
32	25	1"	26	22	2003-02U
40	32	1"1/4	32	27	2003-03U
50	40	1"1/2	37	30	2003-04U
63	50	2"	44	37	2003-05U

PP-H METRIC SOCKET

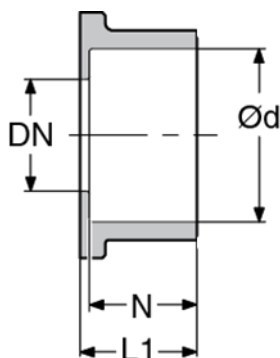

Dimensions					PRODUCT CODE
d	DN	G	L1	N	PP-H
mm	mm	inch	mm	mm	
20	15	1/2"	21	17	2016-00Z
25	20	3/4"	22,5	18	2016-01Z
32	25	1"	24	20	1003-02Z
40	32	1"1/4	27	22	1003-03Z
50	40	1"1/2	30,5	25	1003-04Z
63	50	2"	35,5	29,5	1003-05Z

PP-H METRIC SPIGOT

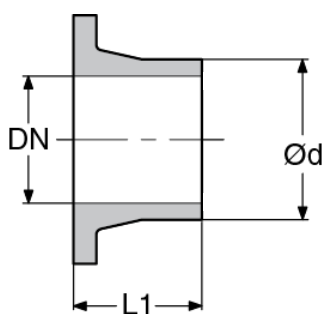

Dimensions				PRODUCT CODE
d	DN	G	L1	PP-H
mm	mm	inch	mm	
20	15	1/2"	49,5	2016-00F
25	20	3/4"	49,5	2016-01F
32	25	1"	49	2016-02F
40	32	1"1/4	49	2016-03F
50	40	1"1/2	48	2016-04F
63	50	2"	48	2016-05F

PE-HD METRIC SOCKET

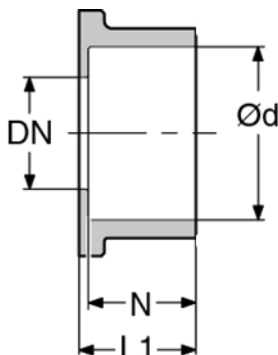

Dimensions					PRODUCT CODE
d	DN	G	L1	N	PE-HD
mm	mm	inch	mm	mm	
20	15	1/2"	20,5	16,5	2024-00B
25	20	3/4"	22,5	18	2024-01B
32	25	1"	23,5	20	2024-02B
40	32	1"1/4	26	22	2024-03B
50	40	1"1/2	30	25	2024-04B
63	50	2"	35	29,5	2024-05B

PE-HD METRIC SPIGOT FOR ELECTROFUSION

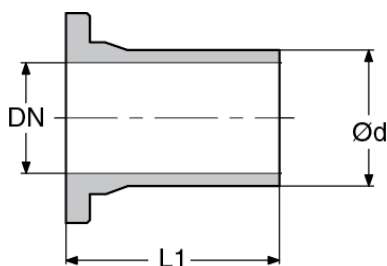

Dimensions				PRODUCT CODE
d	DN	G	L1	PE-HD
mm	mm	inch	mm	
20	15	1/2"	85	2024U00V
25	20	3/4"	85	2024U01V
32	25	1"	88	2024U02V
40	32	1"1/4	90	2024U03V
50	40	1"1/2	87	2024U04V
63	50	2"	110	2024U05V

PVDF BSP THREADED SOCKET

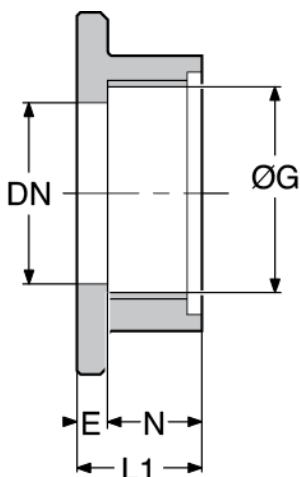

Dimensions					PRODUCT CODE
G	DN	E	L1	N	PVDF
inch	mm	mm	mm	mm	
1/2"	15	-	22,5	17,5	2027-10E
3/4"	20	-	25,5	20,5	2027-11E
1"	25	6,5	29	22	2027-02E
1"1/4	32	7	30	24	2027-03E
1"1/2	40	8	31	24	2027-04E
2"	50	8,5	32,5	24	2027-05E

PVDF METRIC SOCKET

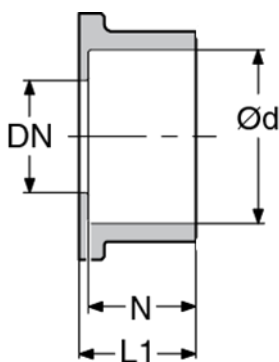

Dimensions					PRODUCT CODE
d	DN	G	L1	N	PVDF
mm	mm	inch	mm	mm	
20	15	1/2"	21,5	17	2027-10Z
25	20	3/4"	22,5	18	2027-11Z
32	25	1"	24,5	20	2027-02Z
40	32	1"1/4	26	22	2027-03Z
50	40	1"1/2	31	25	2027-04Z
63	50	2"	36	29,5	2027-05Z

Assembly of "DIN/ANSI" flange, nut, socket and O-ring

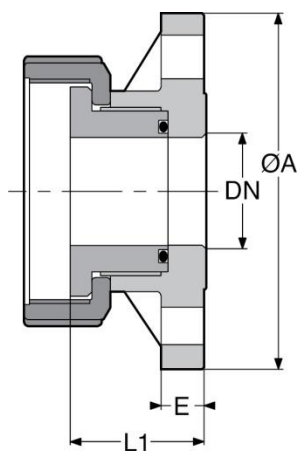

Dimensions					PRODUCT CODE
DN	G	ØA	E	L1	PVDF
mm	Inch.	mm	mm	mm	
15	1/2"	-	-	-	Consult us
20	3/4"	-	-	-	Consult us
25	1"	115	15,5	41	2027-02U
32	1"1/4	140	18	47	2027-03U
40	1"1/2	150	17,6	50,5	2027-04U
50	2"	165	19	60,5	2027-05U

DIN = Drilling in accordance with EN 1092-1 PN10/PN

ANSI = Drilling in accordance with EN1759-1/ASME B16.5 Class 150

ABS METRIC SOCKET

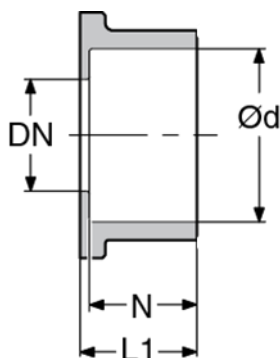

Dimensions					PRODUCT CODE
d	DN	G	L1	N	ABS
mm	mm	inch	mm	mm	
20	15	1/2"	23,5	20	2024-00M
25	20	3/4"	23,5	20	2024-01M
32	25	1"	27	23	2024-02M
40	32	1"1/4	32	27	2024-03M
50	40	1"1/2	38	32	2024-04M
63	50	2"	44	37	2024-05M